

Exterior and Interior WALL MANUAL

METRIC VERSION



Credits, front cover:

Left column

1. Architect: Shope Reno Wharton, Photo: Robert Benson
2. Architect: Gaylord Grainger, Libby O'Brien-Smith Architects,
Photo: Eduardo Calderon
3. Architect: Meyers and D'Aleo, Inc., Photo: Otto Baitz

Centre column

1. Architect: Gary Tabasinske, AIA, Photo: Chris Eden
2. Architect: Alfredo De Vido Associates, Photo: Paul Warchol

Right column

1. Architect: Tanner and VanDine Architects, Photo: Mark Citret
2. Architect: Archimedia, Photo: George Kennedy, AIA & Cosby Bowyer, Inc.
3. Photo: Celia Pearson

INTRODUCTION

This manual is intended for use with Western Red Cedar and Alaskan Yellow Cedar shingle and shake applications only. Western Red Cedar products manufactured by CSSB members are labeled with the "Certi" brand name. Alaskan Yellow Cedar products manufactured by CSSB members are labeled with "Yellow Cedar" at the top of their label. For ease of reference this manual refers to "Certi-label™ Western Cedar" and the term is understood to include both Western Red Cedar and Alaskan Yellow Cedar products manufactured by CSSB members.

Certi-label™ Western Cedar shingles and shakes are the ideal exterior wall cladding for new construction and remodeling. They bring life in the form of beauty, texture, durability, insulative quality, and low maintenance to any building. Restyling with Certi-label Western Cedar shingles or shakes is easily accomplished, whether replacing the previous wall material (re-wall) or applying right over the existing wall (over-wall).

Exterior and Interior Walls Construction Manual

Material for this manual has been compiled from various authoritative sources, and many of the construction methods shown herein have been developed by the shingle and shake specialists in both the United States and Canada. The design and application details and methods of construction reflect current good building practice. Other options are possible but ensure that you check with your local code jurisdiction for approval.

The information in this manual is not intended to supersede local building codes.

Cedar Shake & Shingle Bureau History

On June 9, 1915, at a meeting of the Trustees of the West Coast Lumber Manufacturers Association, it was agreed to establish a branch of the association to serve those members who manufactured shingles. The Red Cedar Shingle Bureau was formed as a separate entity on June 1, 1923. In 1956, the Hand-Split Red Cedar Shake Association was formed. Our influence grew, and as we survived both the Great Depression and World War II, manufacturers continued their quality commitment. In 1963 the shake and shingle associations merged to become the Red Cedar Shingle & Handsplit Shake Bureau.

In the late 1980s, mill quality control inspections were subcontracted to independent, third party quality control agencies.

Each year the Cedar Shake & Shingle Bureau's staff answer thousands of technical questions and product selection queries. Our proud history, quality reputation and dedicated members provide excellent Certi-label Western Cedar shingle and shake siding and roofing products.

Certi-label™ Products

Certi-label Western Cedar shingles and shakes manufactured by members of the Cedar Shake & Shingle Bureau ("CSSB") are the only products labeled with the "Certi" brand name. Certi-label Western Cedar shingles and shakes are made by experienced craftsmen who take pride in their trade and the quality of their product. Despite their varying sizes and sometimes remote locations, member mills are bound together by a rigid quality code. Unannounced independent inspections conducted by accredited third party agencies ensure that product quality is maintained. Products are inspected to conform with various local, national and international codes and standards (contact the CSSB for specific details).

All CSSB member product has the mill's distinctive Certi-label tucked under the bundle strap or printed on the carton. Asking for "the blue label" or "number one blue label" is not specific enough: CSSB members' products are the only ones with the *Certi* brand name on the label.

Approved Installer Guidelines

Good workmanship is crucial to the integrity of any sidewall system. Installers should read this manual carefully and ensure that they follow proper workmanship practices. CSSB Approved Installers agree to follow the guidelines in this manual, or local code regulations, if stricter than the guidelines contained in this manual.

Application Note

Certi-label Western Cedar shingles and shakes are applied on walls in a different manner than on roofs. The major point of difference is in permissible weather exposures - on walls the maximum weather exposure is greater than it is on roofs. A given area of wall, therefore, will require less material than the same area of roof.



Architect: Gary Tabasinske, AIA, Photo: Chris Eden

Product Warranty

The CSSB administers a product warranty for certain product applications performed by an Approved Installer. Consult warranty documentation for specific details.

Note: This manual replaces all previous metric versions of the "Cedar Shake and Shingle Bureau Design and Application Manual for Exterior and Interior Walls"

CONTENTS

Certi-label Products	pages 1-3
Exterior New Wall Construction	pages 4,6,7,8,9
Sidewall Fastener Guidelines	page 5
Exterior Over-Wall and Re-Wall Construction	page 10
Interior Wall Construction	page 11
Sidewall Application Guidelines	page 12
Sidewall Finishing	page 13
Sidewall Coverage Tables	pages 14, 15
How to Read a Certi-label	page 16

CERTIGRADE® WESTERN CEDAR SHINGLES

Number 1 Blue Label®



The premium grade of shingles for sidewalls and roofs. These top-grade shingles are 100% heartwood, 100% clear and 100% edge grain. Available in 406mm or 457mm or 610mm lengths.

Number 2 Red Label



A good grade for many applications. Not less than 254mm clear on 406mm shingles, 279mm clear on 457mm shingles and 406mm clear on 610mm shingles. Flat grain and limited sapwood are permitted in this grade.

Number 3 Black Label



A utility grade for economy applications and secondary buildings. Not less than 152mm clear on 406mm and 457mm shingles, 254mm clear on 610mm shingles.

Number 4 Undercoursing



A utility grade for undercoursing of double coursed sidewalls only. Not a roofing material and not to be used as a starter course for roofs.

CERTI-LABEL WESTERN CEDAR SHAKES

Certi-Split® Handsplit Shakes



These shakes have split faces and sawn backs. Cedar logs are first cut into desired lengths. Blanks or boards of proper thickness are split and then run diagonally through a bandsaw to produce two tapered shakes from each blank. Available in Premium Grade (100% edge grain) or Number 1 Grade (Up to 20% flat grain allowed in each bundle).

Certi-Sawn® Tapersawn Shakes



These shakes are sawn both sides. Premium and Number 1 Grades are the most common. Premium Grade is 100% edge grain, 100% clear and 100% heartwood. Number 1 Grade allows up to 20% flat grain in each bundle. Number 2 and 3 Grades are also available.

Certi-Split® Tapersplit Shakes



Produced by hand, using a sharp bladed steel froe and a mallet. The natural shingle-like taper is achieved by reversing the block, end-for-end, with each split. Premium Grade only.

Certi-Split® Straight-Split Shakes



Produced by machine or in the same manner as tapersplit shakes except that by splitting from the same end of the block, the shakes acquire the same thickness throughout. Premium Grade only.

Note: Western Cedar's natural color varies.

SPECIALTY CERTI-LABEL WESTERN CEDAR SIDEWALL PRODUCTS

Certigrade® Rebutted & Rejointed Shingles



Also known as R&R products, these materials have the same specifications as Number 1 and Number 2 Certigrade shingles, but they are machine re-trimmed for parallel edges and with smooth butts sawn at right angles where a uniform appearance is desired. They are primarily used for sidewall applications. Rebutted & rejointed shingles are also available with a smooth sanded face, with the length of the sanded face at a length greater than the maximum exposure. They are manufactured from 406mm, 457mm and 610mm lengths.

Certigroove® Machine Grooved Shingles



Machine grooved shingles are manufactured as a rebutted & rejointed shingle with one face striated for a length greater than the maximum exposure. Machine grooved products are for sidewall applications only, and are remanufactured from 406mm, 457mm and 610mm shingles.

Certi-Cut™ Shingles

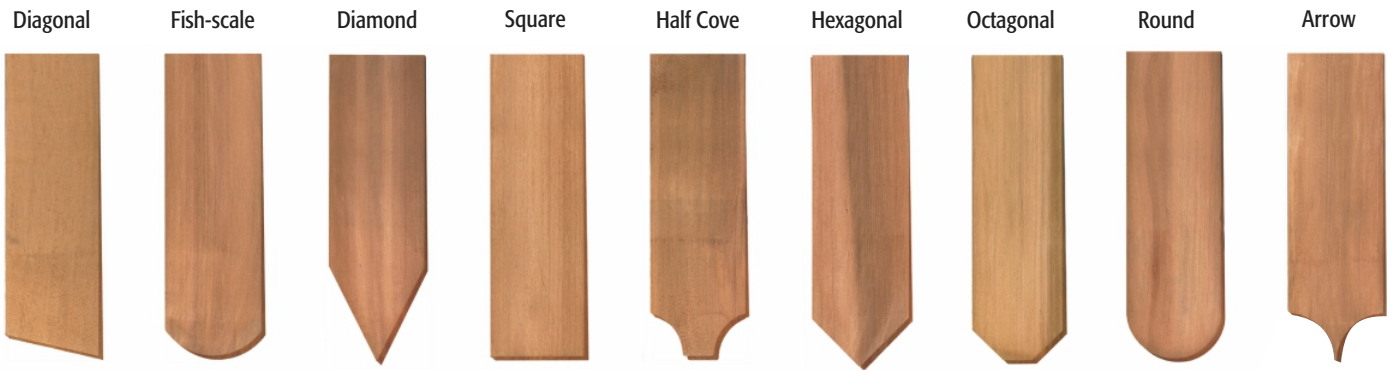

CERTI-CUT SHINGLES These shingles are 127mm wide and are manufactured from 406mm and 457mm lengths. A 96 piece carton will cover 2.32 m² at 190mm exposure. Nine of the most popular designs are shown. Certi-Cut shingles can also be custom produced to meet individual design specifications.

Note: Western Cedar's natural color varies.

Sidewall Carton Packaging Example

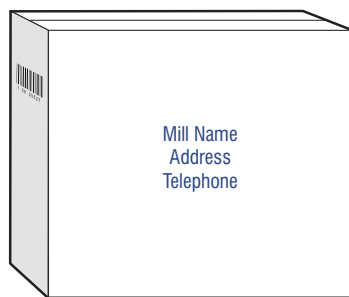

Half Carton



Look for the Certi-label on the carton.

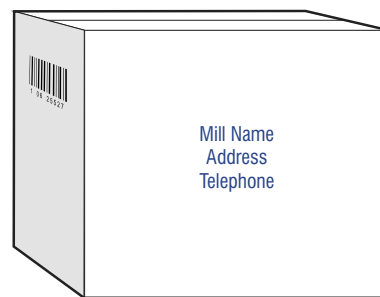

Full Carton

CERTI-GUARD®PRESSURE-TREATED FIRE-RETARDANT SHAKES & SHINGLES
CEDAR SHAKE & SHINGLE BUREAU**CERTI-GUARD®**PRESSURE-TREATED FIRE-RETARDANT SHAKES & SHINGLES
CEDAR SHAKE & SHINGLE BUREAU**CERTI-LAST®**PRESERVATIVE TREATED CEDAR SHAKES & SHINGLES
CEDAR SHAKE & SHINGLE BUREAU**Pressure-Impregnated Treated Products**

Certi-label products can also be treated. Products are available either fire-retardant-treated OR preservative-treated. Special care must be taken to follow the treatment company's recommended installation instructions.

Certi-Guard® Fire-Retardant Treated Western Cedar Shingles and Shakes

Number 1 Grades of Certigrade shingles, and Premium and Number 1 Grades of Certi-Split shakes and Certi-Sawn shakes are available pressure-impregnated with fire retardants. Contact the treatment company for treatment warranty information, accessory product requirements (including recommended fastener types) and application details for treated Western Cedar material. Local code jurisdictions may have additional information regarding applications in specific areas.

Certi-Last® CCA Preservative-Treated Western Cedar Shingles and Shakes

Number 1 Grades of Certigrade shingles, and Premium and Number 1 Grades of Certi-Split shakes and Certi-Sawn shakes are available preservative-treated by pressure processes. This product is ideal in areas of high humidity. Specify the Certi-Last treating label for this extra protection. Contact the treatment company for treatment warranty information, accessory product requirements (including recommended fastener types) and application details for treated Western Cedar material.

Note: Once Western Cedar shingles and shakes are pressure-impregnated treated you must contact the treatment company to determine if a finish, such as paint or stain, is allowable.

Certi-label Sidewall Application Tips

Certi-label Western Cedar shingle and shake size, exposure, width of joints, width of product, kiln versus air-drying process, moisture content and the local environment will all affect the expansion/contraction of Certi-label Western Cedar sidewall products. These factors should always be taken into consideration when determining the installation details and adequate spacing needed for your specific project. Consult with your Approved Installer and refer to page 4 of this manual for more lateral spacing details.



Architect: Shope Reno Wharton, Photo: Robert Benson

Design and Application Details

The instructions given here are not meant to supercede local code requirements. Check with your local building official for their preference in your area.

Preparation - Be sure that the walls are smooth, without protuberances. Nail ends or points should be removed or pounded flush.

Underlayment - The CSSB recommends a Type 30 ASTM Designation 226 (ASTM D 226) or ASTM Designation 4869 (ASTM D 4869) felt underlayment materials. Apply it horizontally, with a staple gun, starting at the base of the wall, with a 51mm horizontal overlap with each succeeding course, and a 152mm overlap vertically when starting a new roll. Wrap the Type 30 felt underlayment 102mm each way around both inside and outside corners.

Corner Boards - Install corner boards (Figure 8) at this time.

Flashing - Flashings associated with doors, windows, and penetration details should be in accordance with good building practice.

Laying Out - Determine the number of Certi-label courses by measuring the height of the wall at the lowest part of the foundation, from a point 25mm below the top of the foundation, to the top of the wall. Divide the height into equal parts, corresponding closely to the weather exposure, but not exceeding the maximum weather exposure recommended. Transfer this measurement and the number of Certi-label courses to a storypole (Figure 1), to lay out courses on all other walls.

Whenever possible butt lines should align with tops or bottoms of windows or other openings, and for appearance the exposure of the final course at the top should match those below.

Certi-label Western Cedar shingle and shake size, exposure, width of joints, width of product, kiln versus air-drying process, moisture content and the local environment will all affect the expansion/contraction of Certi-label Western Cedar sidewall products. These factors should always be taken into consideration when determining the installation details and adequate spacing needed for your specific project. Consult with your Approved Installer and refer to Figure 2: Spacing Detail.

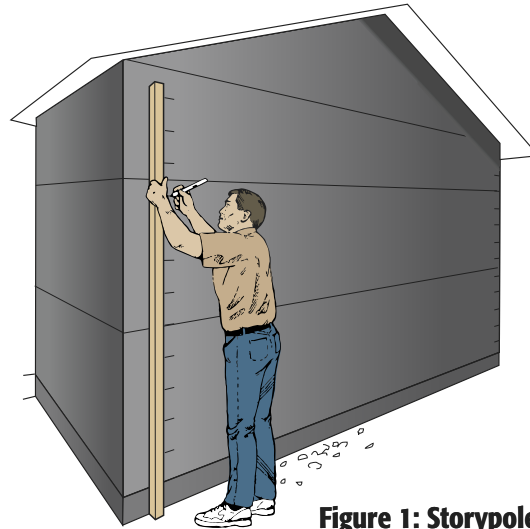

Figure 1: Storypole

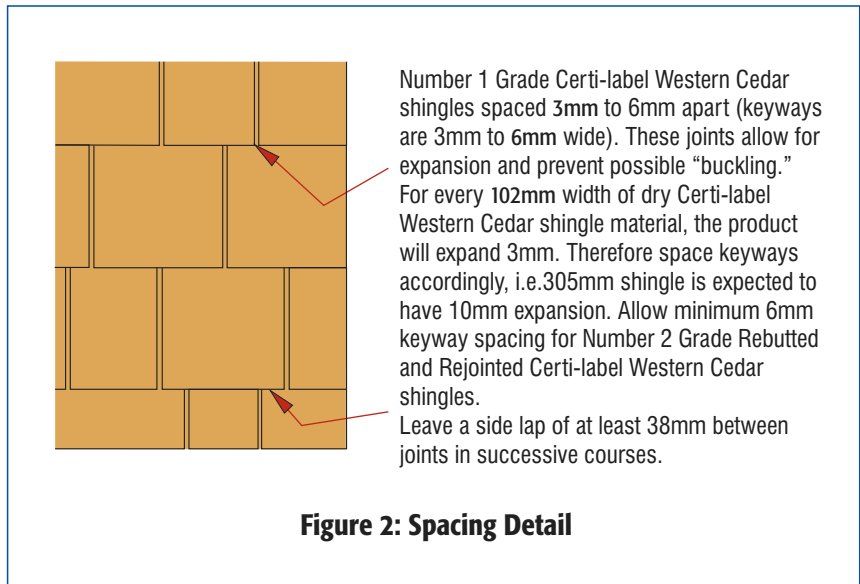

Figure 2: Spacing Detail

Figures 3a and 3b: To prevent the wicking of water, which may cause staining, keep a 13mm clearance between the first course of Certi-label products from all surfaces below.

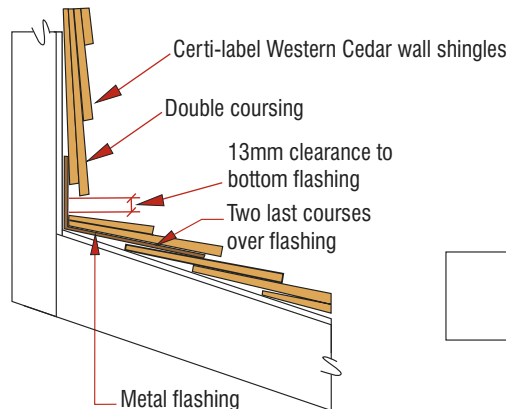

Figure 3a: Flashing

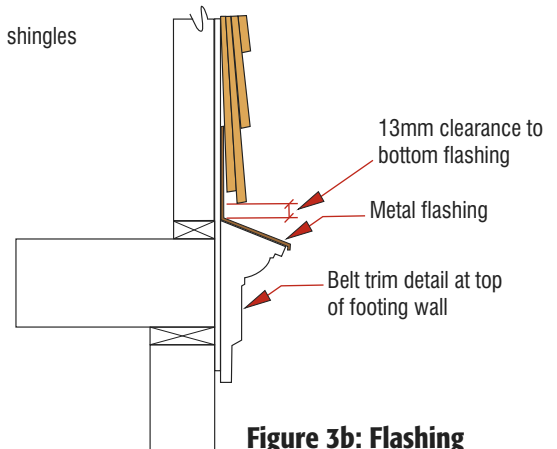

Figure 3b: Flashing

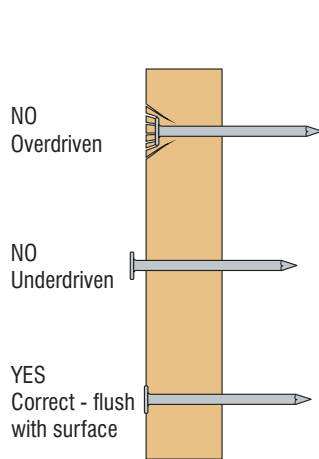

Figure 4:
Nail Driving Detail

Nails

Each Certi-label Western Cedar shingle or shake shall be applied with two fasteners. Nails **must be** stainless steel-type 316 in locations within 24.14 km of salt water. (Ref. Stainless Steel Industry of North America-Washington, D.C. www.ssina.com). For locations outside the salt water zone – nails **must be** Type 304 or 316 stainless steel, or hot-dipped zinc coated galvanized conforming to minimum standard ASTM A 153 Class D (28 grams/0.09m²) or better. Stainless steel nails although more expensive, offer the highest degree of corrosion resistance. Contact the nail manufacturer for further information to ensure the nail used is correct for your application. Minimum nail lengths are shown in the fastener chart below. In double course applications, the exposed Certi-label Western Cedar shingle or shake shall be face-nailed with two hot-dipped galvanized or stainless steel casing nails, driven 51mm above the butt line, and 19mm from each edge.

Certi-label Western Cedar shingles wider than 254mm require 2 additional nails and these two nails are driven approximately 25mm apart near the center of the shingle.

Staples

If you choose to use staples they **must be** stainless steel Type 316 in locations within fifteen (24) km of salt water. (Ref. Stainless Steel Industry of North America-Washington, D.C. , www.ssina.com). For locations outside the of the salt water zone –stainless steel staples Type 304 or 316 **must be** used.

Two staples should be driven per Certi-label Western Cedar shingle or shake with the staple crowns 11mm minimum horizontal, maximum 19mm horizontal, to the Certi-label Western Cedar shingle or shake butt. Staples are driven in the same location as nails relative to the sides and overlapping butt line. Certi-label Western Cedar shingles wider than 254mm require 2 additional staples and these two staples are driven approximately 25mm apart near the center of the shingle.

Fasteners should be long enough to penetrate into the sheathing at least 19mm or all the way through and driven flush with the surface of the Certi-label Western Cedar shingle or shake. In all applications, staples shall be concealed by the course above. **Fasteners cannot be electro-galvanized. Nails are preferred, for aesthetic reasons, in sidewall applications using exposed fasteners.**

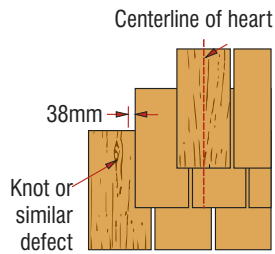

Figure 5:
Course Alignment

Important Notes:

Underdriving or overdriving any fastener will affect the integrity of the Certi-label Western Cedar sidewall system.

Certi-Guard (fire-retardant-treated) or Certi-Last (preservative-treated) Western Cedar shingles and shakes:

ALWAYS ask the treatment company which fasteners are recommended for use with their pressure-treated Certi-label Western Cedar shingles and shakes. Some fasteners are not compatible with treated material.

The information on this page is not meant for use with sidewall panel applications. Please contact the manufacturer for specific panel fastener details.

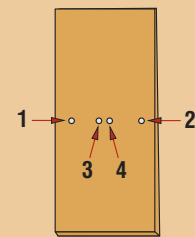

Wide Shingle Fastener Detail

Single Course Sidewall Fasteners

Product Type	Nail Type & Minimum Length
Certigrade, R&R and Sanded Shingles	Type (in)
406mm and 457mm Shingles	3d Box 32mm
610mm Shingles	4d Box 38mm
Certigroove Shingles	Type (in)
406mm and 457mm Shingles	3d Box 32mm
610mm Shingles	4d Box 38mm
Certi-Split & Certi-Sawn Shakes	Type (in)
457mm Straight-Split Shakes	5d Box 45mm
457mm and 610mm Handsplit Shakes	6d Box 51mm
610mm Tapersplit Shakes	5d Box 45mm
457mm and 610mm Tapersawn Shakes	6d Box 51mm

Double Course Sidewall Fasteners

Product Type	Nail Type & Minimum Length
Certigrade, R&R and Sanded Shingles	Type (in)
406mm and 457mm Shingles	5d Box 45mm or same size casing nails
Certigroove Shingles	Type (in)
406mm, 457mm and 610mm Shingles	5d Box 45mm
Certi-Split & Certi-Sawn Shakes	Type (in)
457mm Straight-Split Shakes	7d Box 57mm or 8d 64mm
457mm and 610mm Handsplit Shakes	7d Box 57mm or 8d 64mm
610mm Tapersplit Shakes	7d Box 57mm or 8d 64mm
457mm and 610mm Tapersawn Shakes	7d Box 57mm or 8d 64mm

Single Coursing

Double the starting course at the base of the wall (Figure 6). Apply with 3mm to 6mm keyway space between Certi-label Western Cedar shingles, giving a pronounced individual effect to each course.

Offset the side joints in any one course at least 38mm over joints in adjacent courses (Figure 2).

Use a straight edge, nailing it lightly to the wall with the edge at the butt line (to keep courses straight and level). Check for level every 3 or 4 courses.

This wall application features concealed nailing (Figure 6), with nails driven approximately 25mm above the butt line of the succeeding course. For Certi-label Western Cedar shingles up to 254mm wide, place two nails in each shingle 19mm from each edge. With Certi-label Western Cedar shingles wider than 254mm, drive two additional nails approximately 25mm apart near the center.

Because Certi-label Western Cedar shingles vary in width there should be little waste. At corners, or at door or window frames, you may have to trim a selected Certi-label Western Cedar shingle slightly.

The CSSB recommends installing over plywood panel or dimensional lumber sheathing. If other sheathing materials are approved for use by your local building official, the holding power of the fasteners should also be considered carefully.

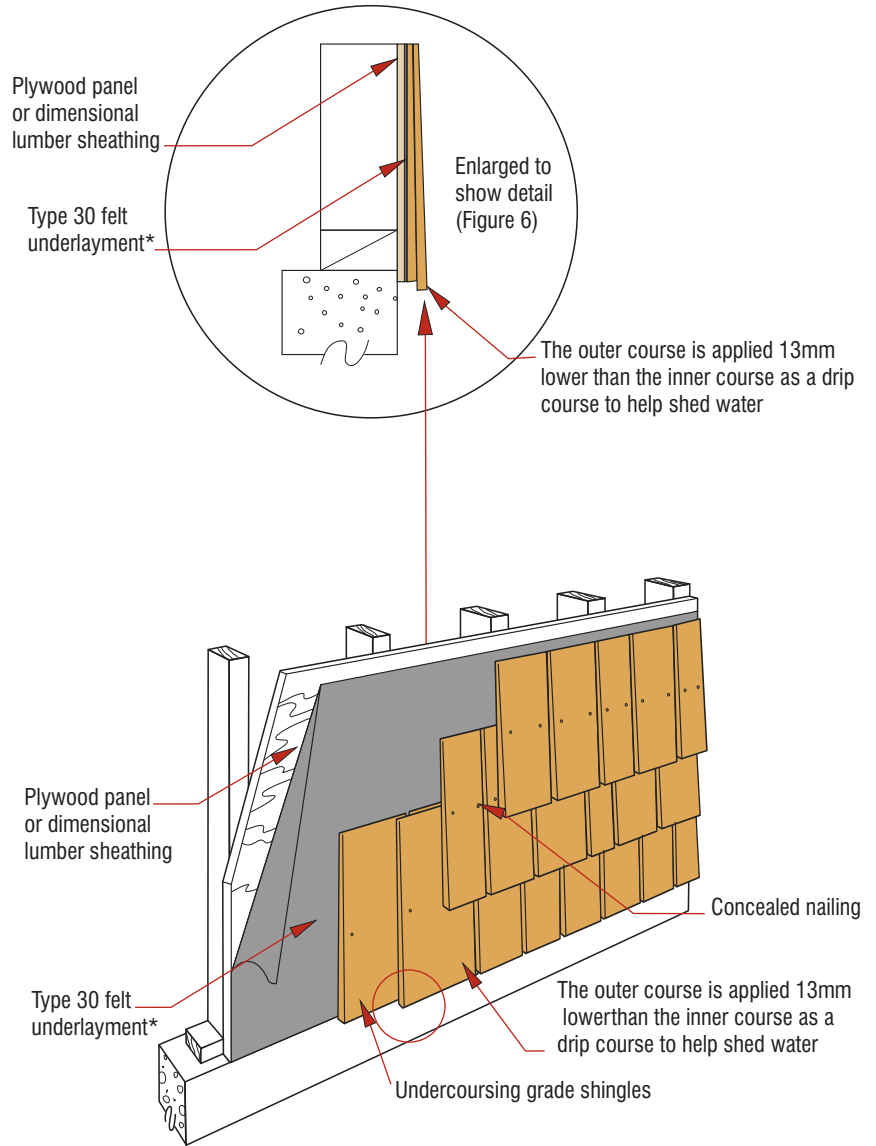

*The Cedar Bureau recommends Type 30 ASTM Designation 226 (ASTM D226) or ASTM Designation 4869 (ASTM 4869) felt underlayment and will refer to required underlayment as Type 30 throughout this manual. Check with your local building official for any questions about alternative underlayment materials.

Figure 6: Single Coursing



Architect: Shope Reno Wharton, Photo: Robert Benson

Double Coursing

To obtain an attractive wall characterized by wide weather exposures and deep shadow lines, Certi-label Western Cedar shingles and shakes can be applied double coursed. This method offers economy because of the wide exposures of the outer course and the use of less expensive undercoursing Certi-label Western Cedar shingles for the under layer (Figure 7). For double coursing exposure details refer to the chart on page 12.

In double coursing, the bottom or starter course is laid triple with two undercourse Certi-label Western Cedar shingles or one undercourse Certi-label Western Cedar shingle over a wood lath and then the outer course. This gives the bottom course the same slant as succeeding courses. All outer courses are applied 13mm lower than the undercourse (Figure 7). A straight edge can be used to facilitate placement and nailing of both the undercourse and exposed course.

Undercourse Certi-label Western Cedar shingles are fastened at the top with one nail or staple in the center. The exposed Certi-label Western Cedar shingle or shake is face-nailed with two casing-type nails, driven approximately 51 mm above the butt line, 19mm from each edge. With Certi-label Western Cedar shingles wider than 254mm drive two additional nails approximately 25mm apart near the center.

The CSSB recommends installing over plywood panel or dimensional lumber sheathing. If other sheathing materials are approved for use by your local building official, the holding power of the fasteners should also be considered carefully.

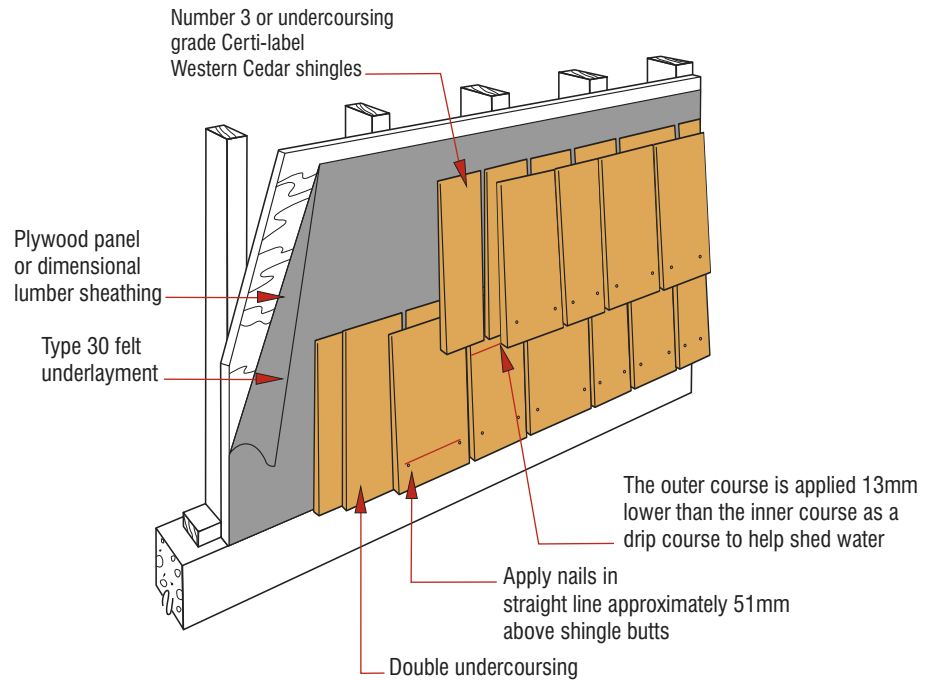

Figure 7: Double Coursing



Architect: Tanner and VanDine Architects, Photo: Mark Citret

Corners

Neatly fitting inside or outside corners are easily made. It is standard practice to lace outside corners (Figure 8e). On wide exposures this method requires small nails near the Certi-label Western Cedar shingle butts to tighten and hold the lapped corners. For these corners use only nails that are corrosion resistant. In double course applications, the exposed Certi-label Western Cedar shingle or shake shall be face-nailed with two hot-dipped galvanized or stainless steel casing nails, driven 51mm above the butt line, and 19mm from each edge. Certi-label Western Cedar shingles wider than 254mm require 2 additional nails and these two nails are driven approximately 25mm apart near the center of the shingle. Corner boards also can be used to advantage by nailing a 19mm x 89mm cedar board to a 19mm x 64mm cedar board, then attaching the preassembled corner to the building (Figure 8a).

It is good practice to use flashing behind Certi-label Western Cedar shingles or shakes at the inside corners. They may be butted against a square wood strip (Figure 8b), or they may be fitted one course to the other (Figure 8d). When the latter method is used, courses must be completed on each wall progressively, and can be best applied by working from the corners while alternately fitting one course to the other. (Figure 9)

It is preferred practice to install inside/outside corner flashing to safeguard against the cracking or tearing of Type 30 felt underlayment at these corners.

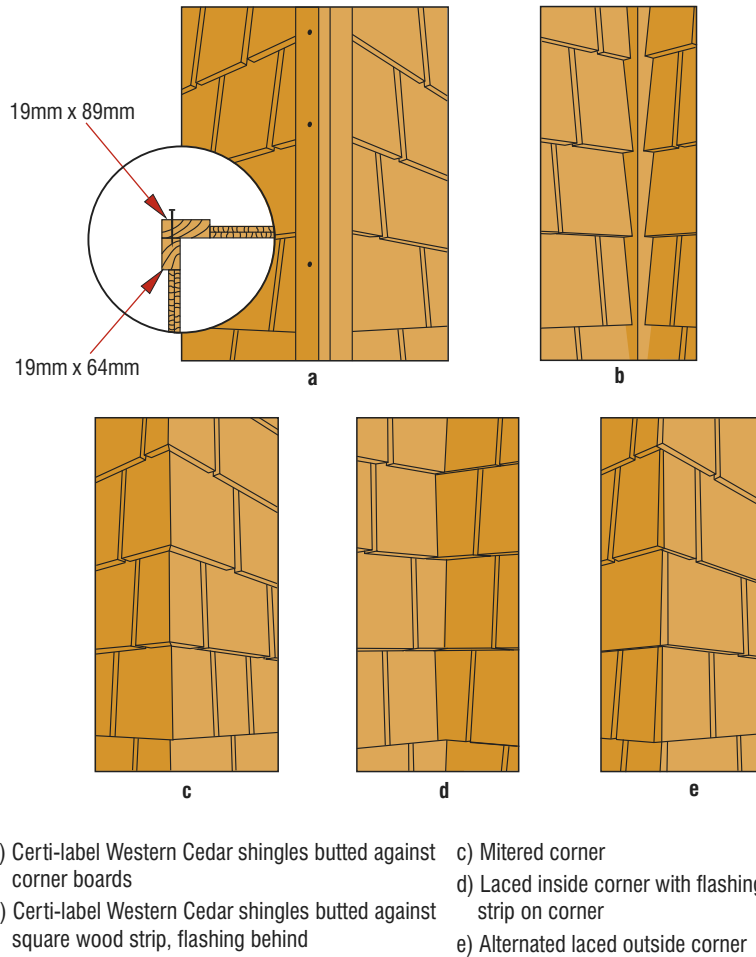

Figure 8: Corner Option Details

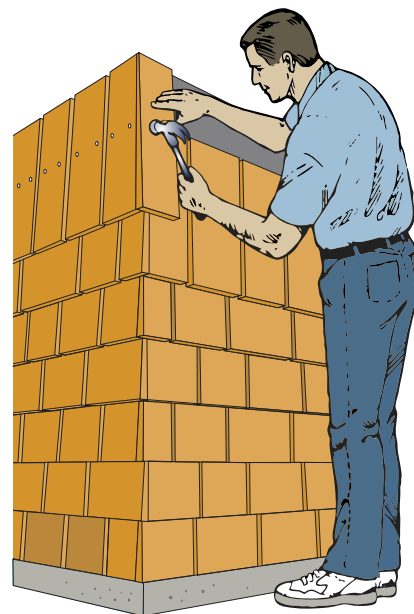

Figure 9: Fitting Laced Corner Courses

Design and Application Instructions

Staggered Butt Coursing

For single course application, an attractive effect can be made by staggering the butt of the Certi-label Western Cedar shingle from the horizontal line. Apply the Certi-label Western Cedar shingle irregularly at variable distances below (but not above) the horizontal line.

Staggered butt applications are made by shortening the exposure less than the greater maximum exposure. No Certi-label Western Cedar shingles or shakes shall be applied greater than the maximum exposure allowed. Check with local building codes for approval of the staggered butt coursing installation method.

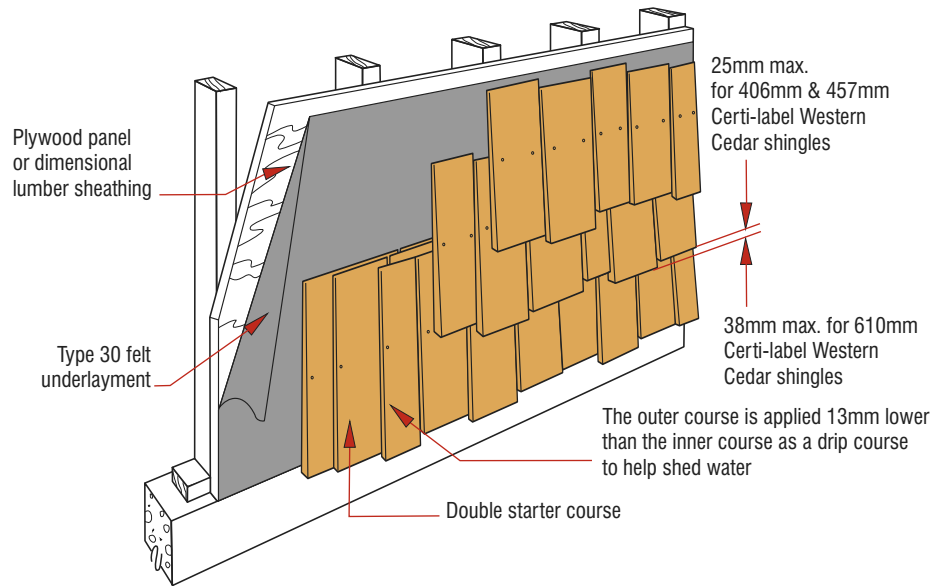

Figure 10: Staggered Coursing



Architect: Alfredo De Vido Associates, Photo: Paul Warchol

Butt nail all double coursed Certi-label Western Cedar shingles that are exposed more than their maximum single course exposure.

Ribbon Coursing

A double shadow line effect can be obtained by raising the outer course Certi-label Western Cedar shingles approximately 25mm above the undercoursing. Use Number 1 Grade Certi-label Western Cedar shingles for undercoursing when applying ribbon coursing (Figure 11).

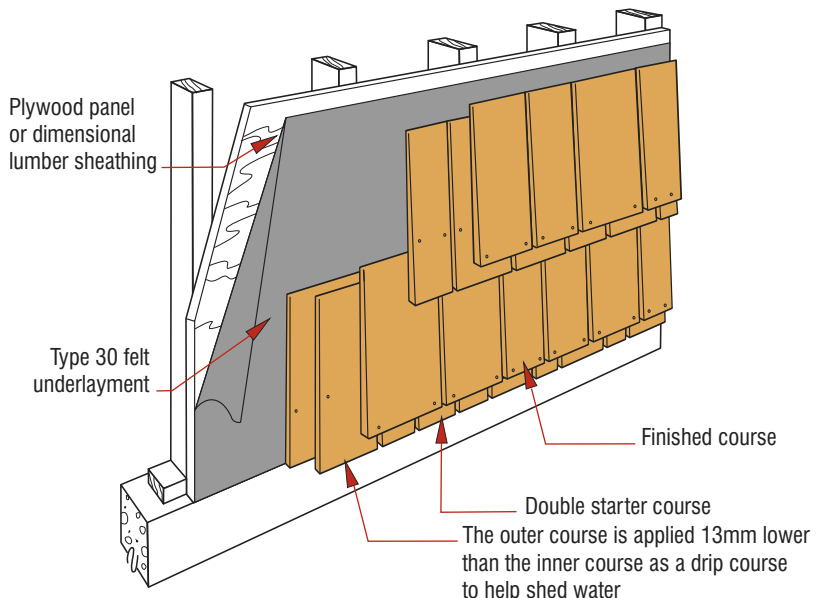

Figure 11: Ribbon Coursing

Design and Application Instructions

Re-walling

Once the old exterior wall material has been removed and the old nails or other protrusions cleaned away, the new wall can be applied. Type 30 felt underlayment should be applied since it is new construction.

Over-walling

Applying Certi-label Western Cedar shingles or shakes right over an old wall - whether wood, brick, stucco, or synthetic products - is easily done. It saves time involved in both removing the old exterior and in disposing of it. However, avoid nailing over vinyl or aluminum as they are not sufficiently strong to provide a proper support.

First, nail moulding strips on the face of existing window and door casings, flush with the outer edges. The Certi-label Western Cedar shingles or shakes are then joined to the mouldings (Figure 12).

Over Beveled Siding - Applying a new Certi-label Western Cedar shingle or shake wall over old beveled siding can be accomplished in either of two ways: 1) By filling in the low points of the wall with low grade lumber or plywood strips (called horse feathers) of appropriate thickness and thereby increasing the potential nailing surface, or 2) by nailing the Certi-label Western Cedar shingles or shakes to the high points of the bevels of each course of the old wall, or of alternate courses (provided it does not result in weather exposure greater than is recommended (Figure 13).

Ensure that the first course is properly attached. All Certi-label Western Cedar shingle and shake product installation must meet nailing and exposure guidelines as detailed in this manual. It may be necessary to add occasional nailing strips.

Over Masonry or Foam Sheathing - Masonry walls are easily covered, by vertically furring the walls and applying nailing strips (1 x 3 or 1 x 4) spaced according to the exposure and single/double course product design. When installing over masonry, the nailing strips should be fastened with special nails, driven between the bricks or blocks, so that the outer shingled wall will be firmly attached.

1. Apply new casing to bring Certi-label Western Cedar shingles or shakes flush with surface
2. The integrity of the original flashing is to be utilized. Additional trim is considered to be decorative only. If the original window does not have good structural integrity, it must be removed and a new one installed. New casings are to be installed as part of proper wall construction as shown throughout this manual.

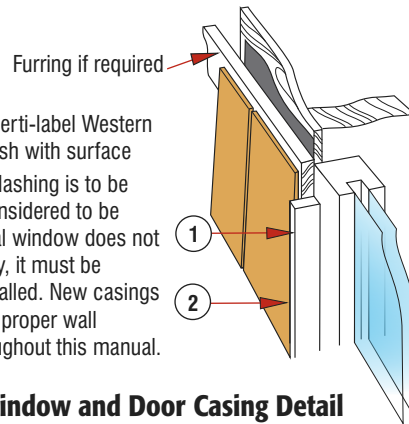
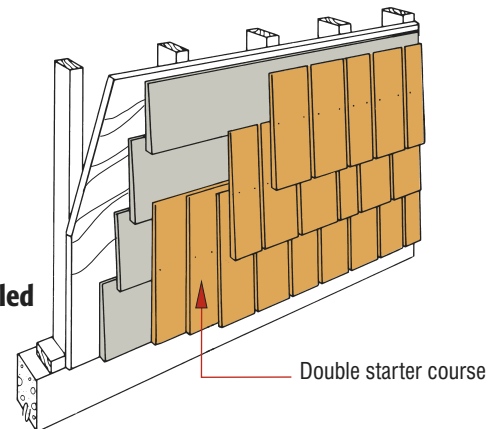

Figure 12: Typical Window and Door Casing Detail

Figure 13: Over Beveled Siding Detail



38mm x 64mm or 38mm x 89mm nailing strips spaced according to exposure of Certi-label Western Cedar shingles or shakes, regardless of single or double course. (See pages 6-7)

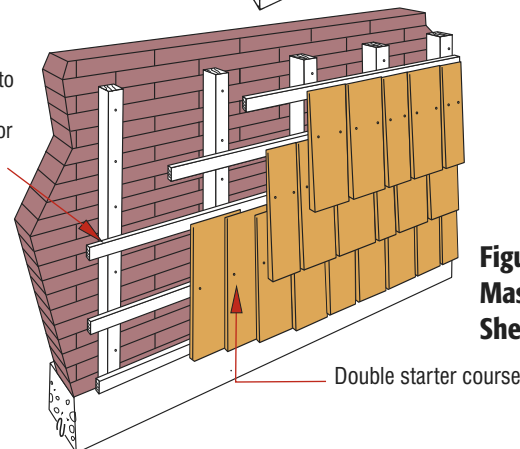

Figure 14: Over Masonry or Foam Sheathing Detail

When installing over foam sheathing, vertical spacers shall be attached with fasteners long enough to penetrate through the foam sheathing and the underlying wood sheathing. Do not apply only to the foam sheathing as it is too weak to provide proper support. (Figure 14).

Over Stucco - Nailing strips should be attached with nails long enough to penetrate the stucco and the underlying sheathing. Do not apply directly to the stucco, which is too weak to provide a proper support. If the old stucco is removed, new Type 30 felt underlayment is then applied to the walls, and the shingling can proceed as in new construction (Figure 15).

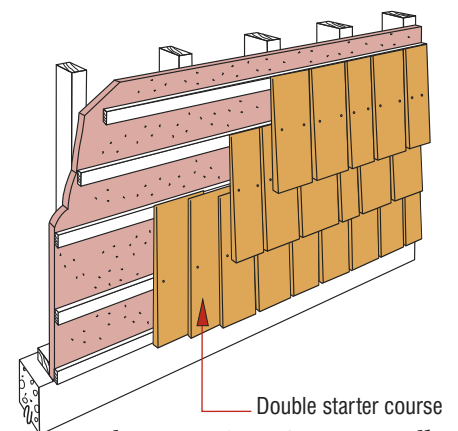

Figure 15: Over Stucco Detail

Design and Application Details

Certi-label Western Cedar shingles or shakes are building materials that adapt easily to many different structural forms. Their use in interiors is practically unlimited, and a wide variety of imaginative effects can be achieved.

Certi-label Western Cedar shingles or shakes can be readily applied over almost any interior wall surface, including wood, brick, plaster, or concrete. Nails, staples, or glue may be used as fasteners on interior wall projects. Certi-label Western Cedar shingles or shakes may be attached directly to the interior wall providing it has sufficient holding qualities to support the fasteners. If this is not the case, they may be applied over spaced furring strips, which are fastened to the wall by nails or glue. As a general rule, the furring strips should be placed a distance apart equal to the desired exposure.

Calculate the number of courses by dividing the wall height (minus the height of the base board, if any) by the desired exposure. Mark the positions of the nailing strips on a furring strip, then transfer these measurements to the wall. Fasten 19mm x 38mm or 19mm x 64mm furring strips to the wall (e.g. by nailing them through the wall into the studs) at the positions marked. If the Certi-label Western Cedar shingles or shakes are to be carried around the corner, make sure the furring strips line up (Figure 16).

Start with a double course at the bottom of the wall. Use two nails or staples in each Certi-label Western Cedar shingle or shake placed so that the nail heads will be covered by the next course. The outer layer should overlap and conceal the side joints of the first course (Figure 17).

Continue with single courses to the top of the wall. A straight edge tacked to the wall will keep the courses true and the exposure consistent.

Alternately overlap the Certi-label Western Cedar shingles or shakes on the outside corner to give a "laced" effect, then trim them flush with a block plane (Figure 18).

Cut the Certi-label Western Cedar shingles or shakes for the last course and discard the thin end. Glue or nail the last course in place to make a neat top edge. A moulding strip may be applied to cover nail heads and hide any irregularities in the ceiling (Figure 19).

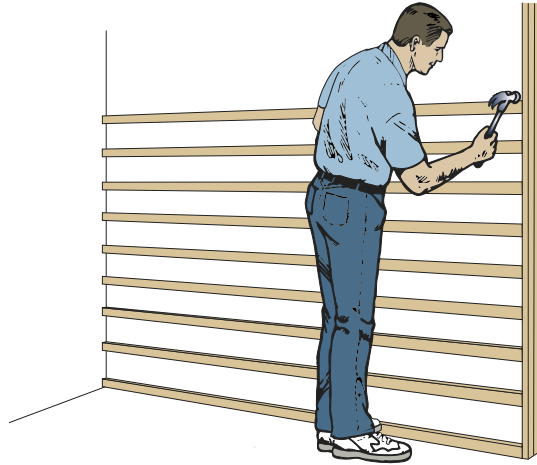

Figure 16: Furring Strip Detail

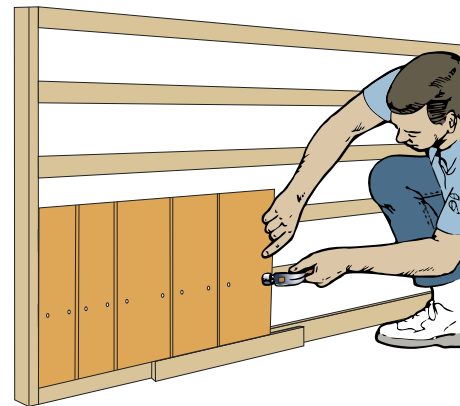

Figure 17: Starter Course

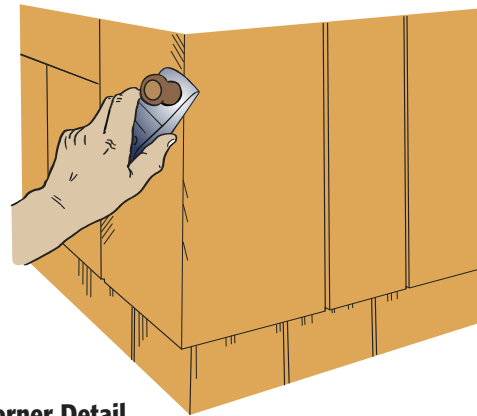

Figure 18: Corner Detail



Figure 19: Top Course

The interior Certi-label Western Cedar shingles or shakes can now be finished to suit almost any taste. Contact a reputable finish manufacturer for more details.

General Application Notes

1. The contractor shall cover all wall surfaces with Certi-label Western Cedar shingles or shakes bearing the Cedar Shake & Shingle Bureau's official grade marked label.
2. Certi-label Western Cedar shingles/shakes for outer courses shall be (specify grade and length).
3. Certi-label Western Cedar shingles/shakes for undercourses shall be (specify grade and length).

Sidewall Application

4. Certi-label Western Cedar sidewall shingles/shakes shall be (doubled or tripled) at foundation lines.
5. Certi-label Western Cedar sidewall shingles shall be spaced apart 3mm to 6mm.
6. Joints of Certi-label Western Cedar shingles/shakes in any one course shall be offset not less than 38mm from the joints in adjacent courses.
7. Certi-label Western Cedar shakes on sidewalls shall be spaced apart not more than 10mm to 13mm.
8. Certi-label Western Cedar sidewall shingles/shakes shall be applied with a weather exposure of (specify in mm from exposure chart).

Fastening Sidewall Shingles/Shakes

9. Fasteners should be long enough to penetrate into the sheathing at least 19mm or all the way through and driven flush with the surface of the Certi-label Western Cedar shingle or shake. In all applications, staples shall be concealed by the course above. Fasteners cannot be electro-galvanized as they will cause staining. For aesthetic reasons, nails are preferred for sidewall applications.

[**Note:** Due to the diverse range of fastener requirements, please refer to the charts on page 5 for fastener specifications].

Sidewall Guidelines

This information has been designed to aid architects, consultants and builders in specifying Certi-label Western Cedar shingles and shakes. It suggests a standardized terminology and style for ordering in the hope of improving accuracy. It incorporates a general outline of the latest application information. Please note, however, that this is an application guide only. **The information in this manual is not intended to supercede local codes.** Refer to local building codes for more information.

Maximum Sidewall Exposure Chart			
Number One Grade Products			
Certi-label Western Cedar Product	Grade	Single Course	Double Course
Certigrade			
406mm Shingles	1	178mm	305mm
457mm Shingles	1	203mm	356mm
610mm Shingles	1	267mm	406mm
406mm R&R, sanded, Certigroove Shingles	1	178mm	305mm
457mm R&R, sanded, Certigroove Shingles	1	203mm	356mm
610mm R&R, sanded, Certigroove Shingles	1	267mm	406mm
Certi-Split			
457mm Handsplit Shakes	1	203mm	356mm
610mm Handsplit Shakes	1	267mm	457mm
57mm Straight Split Shakes	1	203mm	406mm
610mm Tapersplit Shakes	1	267mm	457mm
Certi-Sawn			
457mm Tapersawn Shakes	1	203mm	356mm
16mm Tapersawn Shakes	1	267mm	457mm
Number Two Grade Products			
Certigrade			
406mm Shingles	2	152mm	229mm
457mm Shingles	2	178mm	254mm
610mm Shingles	2	229mm	356mm
406mm R&R, sanded Shingles	2	152mm	229mm
457mm R&R, sanded Shingles	2	178mm	254mm
610mm R&R, sanded Shingles	2	229mm	356mm
Certi-Sawn			
457mm Tapersawn Shakes	2	178mm	254mm
610mm Tapersawn Shakes	2	229mm	356mm

Exterior Finishes (also known as Coatings)

There are a variety of paints, stains, and preservative treatments available for Certi-label Western Cedar sidewall products. Certi-label sidewall products are available pre-finished, (pre-primed or pre-stained) and natural (unfinished).

Please note: A detailed product finishing discussion is beyond the scope of this manual; however, a brief overview is presented below. It is critical to read the instructions on the finish product's container as well as follow the finish manufacturer's directions. All areas of the world present unique painting/staining challenges. Some of the topics you should discuss with your sidewall product manufacturer, finish manufacturer, and professional contractor include the following:

1. Product coverage
 2. Surface preparation
 3. Qualified finish contractors in your area
 4. Certi-label Western Cedar moisture content level recommended for your specific locale
 5. Appropriateness of finish for Certi-label Western Cedar sidewall products
 6. Drying color versus sample chip color
 7. Material Safety Data Sheet
 8. Mildew resistance
 9. UV resistance and water repellency
 10. Exterior/Interior finish usage
 11. Depth of finish penetration
 12. Application method, including how to cover all sides of product, mixing/stirring (to prevent lap marks), temperature, brush versus spraying tools, and recommended proper clean up and disposal of all tools, brushes and rags. Talk to your finish manufacturer if you have questions about back-priming instructions for your particular project.
 13. Price: Do not be fooled by a low price. Better quality brands tend to be more expensive. A cheap finish will usually cost more in the long run through quicker weathering, poorer coverage and less pigment. Use only the highest quality products from your finish manufacturer.
- Quality finish manufacturers have technical help lines you can call (some are toll-free). Advice is also available via the Internet.**

The CSSB recognizes these general types of finishes:

Transparent finishes (penetrating oil-based): clear, allow natural grain to show through, may also include paintable water repellent preservatives. Such treatment can possibly, depending upon the product, inhibit mildew growth as well as rapid change in color due to weathering.

Semi-transparent and semi-solid stains (penetrating oil-based): have some pigment, but allow some wood grain to show.

Paint or solid stain: provide opaque coverage, allowing little to no wood grain to show.

Certi-label Western Cedar Sidewall Finishing Systems: Preferred Paint System

Step 1: Factory or field applied alkyd oil or latex stain blocking primers on all surfaces

Step 2: Field-applied top coat of highest quality 100% acrylic latex paint. This type of top coat is more flexible and more resistant to blistering and cracking. The best protection against extractive bleeding is the application of an oil-based, stain-blocking primer before the top coat is applied.

OR

Less Durable Paint System

Step 1: Factory or field applied alkyd oil or latex stain blocking primers on all surfaces

Step 2: Field-applied oil-based or alkyd top coat. CSSB member manufacturers do supply factory-primed products. These products are usually more cost-effective than on-site priming.

Stains

Use oil-based stains only. CSSB member manufacturers can factory-apply a coat of semi-transparent or semi-solid oil-based stain. This process is usually more cost-effective than on-site staining. Further enhancing the natural durability of Certi-label Western Cedar shingles and shakes, some CSSB members offer pass-through finish warranties on their factory finished sidewall shingles and shakes. These can be further enhanced by application of a final, field-applied top coat. Contact participating CSSB members for details.

To Accelerate the Weathering Process

To hasten the weathering process, apply a bleaching oil finish.

How Soon to Finish

Generally finish products **IMMEDIATELY** after installation **PROVIDING** that the moisture content is appropriate for both the finish product being used and your locale. If the finish is not applied promptly, adhesion will be compromised (unless additional surface preparation is undertaken).

If you have installed a natural product (unfinished), apply your finish before rain and other moisture are absorbed. Ensure that you account for high humidity concerns.

If you are using a pre-finished product (where finish is applied at the manufacturing plant), ensure that the product is thoroughly dried before applying a top finish coat.

In all instances drying time varies from region to region. Excessive moisture will limit finish adhesion. Check with your professional contractor, finish manufacturer and/or sidewall product manufacturer for assistance.

Surface Cleaning

There are products that claim to be effective for removing dirt, airborne pollution marks, mildew and prior finishes. If you clean the surface prior to finishing, ensure that it is allowed to dry to the finish manufacturer's recommended moisture content level before applying a new finish. Contact your finish manufacturer for more details.

Extractive Bleeding

Extractive bleeding is characterized by the tannins in the wood being dissolved in moisture and migrating to the surface of the product. Rain will sometimes wash these stains away; however if left to weather, the sun can cause polymerization, thus requiring the addition of a tannin blocker and new top coat of finish (ensure proper surface preparation before applying new top coat) once the moisture problem has been solved. Compounds containing oxalic acid appear to be the most effective at removing extractive bleeding stains: ensure you use proper safety precautions and follow the oxalic acid compound manufacturer's application directions.

Extractive bleeding does not signify failure of the applied finish, but instead is found in applications where a source of moisture is present. Extractive bleeding is not a manufacturing defect nor is it a finish defect; it is a natural phenomenon that occurs in applications. Tannin blocking products help, however, the CSSB does not provide any finish warranty. Check with your sidewall product manufacturer, finish manufacturer, and professional contractor for more assistance.

The CSSB does not warrant this information or instruction regarding finishes. If you see an attractive job that has endured in your locale, inquire about the type of finish used. **Once Certi-label Western Cedar shingles and shakes are pressure-impregnated treated you must contact the treatment company to determine if a finish, such as paint or stain, is allowable. If there is any confusion whatsoever it is highly recommended that you contact both your sidewall product manufacturer and the finish manufacturer.**

Certigrade Shingles - Coverage (Number 1 Grades)

Approximate coverage, in square meters, of one square (4-bundle roof-pack) of shingles, applied at indicated weather exposures. (Some exposures on this chart are not acceptable for single course application. Consult the maximum exposure table on page 12 for more details).

Exposure →	89mm	102mm	114mm	127mm	140mm	152mm	165mm	178mm	190mm	203mm	216mm	229mm	241mm	254mm
Length and Thickness ↓														
406mm x 5/51mm	6.50 m ²	7.43 m ²	8.36 m ²	9.29 m ²	10.22 m ²	11.15 m ²	12.08 m ²	13.01 m ²	13.94 m ²	14.86 m ²	15.79 m ²	16.72 m ²	17.65 m ²	18.58 m ²
457mm x 5/57mm	–	6.74 m ²	7.57 m ²	8.41 m ²	9.29 m ²	10.13 m ²	10.96 m ²	11.80 m ²	12.63 m ²	13.52 m ²	14.35 m ²	15.19 m ²	16.03 m ²	16.86 m ²
610mm x 4/51mm	–	–	–	–	6.83 m ²	7.43 m ²	8.04 m ²	8.64 m ²	9.29 m ²	9.89 m ²	10.50 m ²	11.15 m ²	11.75 m ²	12.36 m ²

Certigrade Shingles - Coverage (Number 1 Grades), continued

Approximate coverage, in square meters, of one square (4-bundle roof-pack) of shingles, applied at indicated weather exposures. (Some exposures on this chart are not acceptable for single course application. Consult the maximum exposure table on page 12 for more details).

Exposure →	267mm	279mm	292mm	305mm	318mm	330mm"	343mm"	356mm	368mm	381mm	394mm	406mm
Length and Thickness ↓												
406mm x 5/51mm	19.51 m ²	20.44 m ²	21.37 m ²	22.30 m ²	–	–	–	–	–	–	–	–
457mm x 5/57mm	17.74 m ²	18.58 m ²	19.42 m ²	20.25 m ²	21.09 m ²	21.92 m ²	22.81 m ²	23.64 m ²	–	–	–	–
610mm x 4/51mm	13.01 m ²	13.61 m ²	14.21 m ²	14.86 m ²	15.47 m ²	16.07 m ²	16.72 m ²	17.33 m ²	17.93 m ²	18.58 m ²	19.18 m ²	19.79 m ²

Certigroove Shingles/Rebutted & Rejointed Shingles - Coverage (Number 1 Grades)

Approximate coverage, in square meters, of one single-carton sidewall square of machine grooved shingles, rebutted & rejointed shingles, and sanded face shingles applied at indicated weather exposures. (Some exposures on this chart are not acceptable for single course application. Consult the maximum exposure table on page 12 for more details).

Exposure →	152mm	178mm	203mm	229mm	254mm	279mm	305mm	330mm	356mm	381mm	406mm
Length ↓											
406mm	4.65 m ²	5.48 m ²	6.22 m ²	7.06 m ²	7.80 m ²	8.64 m ²	9.29 m ²	–	–	–	–
477mm	3.99 m ²	4.65 m ²	5.30 m ²	5.95 m ²	6.69 m ²	7.34 m ²	7.99 m ²	8.64 m ²	9.29 m ²	–	–
610mm 2 carton wall square (Certigroove only)	3.44 m ²	4.09 m ²	4.65 m ²	5.20 m ²	5.76 m ²	6.41 m ²	6.97 m ²	7.52 m ²	8.08 m ²	8.73 m ²	9.29 m ²
610mm 4 carton wall square	6.87 m ²	8.18 m ²	9.29 m ²	10.40 m ²	11.52 m ²	12.82 m ²	13.94 m ²	15.05 m ²	16.16 m ²	17.47 m ²	18.58 m ²

Coverage Guidelines

- Sidewall squares are calculated in a different manner than roof squares. The number of cartons in a square depends upon the product type. Check with your supplier for more details.
- Remember to deduct window and door areas from coverage calculations.

Product Coverage Calculations

Ensure you have the following information:

1. Size of wall area you are trying to cover, measured in square feet.
2. Application method and exposure to be used
3. Product type used
4. Amount of product in each box (packaging)

Your supplier will be glad to assist you. As usual, always check with your local building official for requirements in your area.

Sidewall Shingle Packaging

- Cartons are made of cardboard, and must be kept dry.
- CSSB member product will be labeled with the Certi-label on the carton.
- Mills pack in 1/2 carton and full carton sizes. Check with your supplier for more details.
- Before starting please read the instructions printed on the carton.**

Certi-Split Shakes-Coverage (Number One or Premium Grades)

Approximate coverage, in square meters, of one square of shakes applied at indicated weather exposures. (Some exposures on this chart are not acceptable for single course application. Consult the maximum exposure table on page 12 for more details).

Exposure →	178mm	216mm	254mm	292mm	356mm	406mm	457mm
Shake Type, Length and Thickness ↓							
457mm x 13mm Handsplit-and-Resawn Mediums	6.50 m ²	7.90 m ²	9.29 m ²	10.68 m ²	13.01 m ²	–	–
457mm x 19mm Handsplit-and-Resawn Heavies	6.50 m ²	7.90 m ²	9.29 m ²	10.68 m ²	13.01 m ²	–	–
457mm Tapersawn	6.50 m ²	7.90 m ²	9.29 m ²	10.68 m ²	13.01 m ²	–	–
610mm x 19mm Handsplit & Resawn	6.50 m ²	7.90 m ²	9.29 m ²	10.68 m ²	13.01 m ²	14.86 m ²	16.72 m ²
610mm x 10mm Handsplit-and-Resawn Mediums	6.50 m ²	7.90 m ²	9.29 m ²	10.68 m ²	13.01 m ²	14.86 m ²	16.72 m ²
610mm x 19mm Handsplit-and-Resawn Heavies	6.50 m ²	7.90 m ²	9.29 m ²	10.68 m ²	13.01 m ²	14.86 m ²	16.72 m ²
610mm Tapersawn	6.50 m ²	7.90 m ²	9.29 m ²	10.68 m ²	13.01 m ²	14.86 m ²	16.72 m ²
610mm x 13mm Tapersplit	6.50 m ²	7.90 m ²	9.29 m ²	10.68 m ²	13.01 m ²	14.86 m ²	16.72 m ²
457mm x 10mm True-Edge Straight-Split (4 bundle square)	4.65 m ²	5.57 m ²	6.60 m ²	7.62 m ²	9.29 m ²	–	–
457mm x 10mm Straight-Split (5 bundle square)	7.62 m ²	9.29 m ²	10.96 m ²	12.54 m ²	15.33 m ²	–	–
610mm x 10mm Straight-Split	6.50 m ²	7.90 m ²	9.29 m ²	10.68 m ²	13.01 m ²	14.86 m ²	16.72 m ²

Starter Course: Underlying course can be the Number 1 Grade product used on outer course or a lower grade product.

Please note: Handsplit shakes are also known as Handsplit-and-Resawn shakes.

Coverage Guidelines

- Sidewall squares are calculated in a different manner than roof squares.
- Remember to deduct window and door areas from coverage calculations.

Product Coverage Calculations

Ensure you have the following information:

1. Size of wall area you are trying to cover, measured in square feet.
2. Application and exposure to be used
3. Product type used
4. Amount of product in each box or bundle

Your supplier will be glad to assist you. As usual, always check with your local building official for requirements in your area.

Sidewall Shake Packaging

- Shakes are packaged in bundles, secured with a metal strap. Each bundle will have a Certi-label underneath.
- While most 457mm shakes are packed in bundles of 12 courses each side (12/12) they may be packed 9/9. This will alter the number of bundles required to cover 1 square.

For example: 457mm shake bundles, 12/12 pack, 5 bundles, should cover 9.29 m² at 190mm exposure.

9/9 pack, 5 bundles, should give 75% coverage of a square at 190mm exposure. When ordering check with your supplier to confirm bundle size.

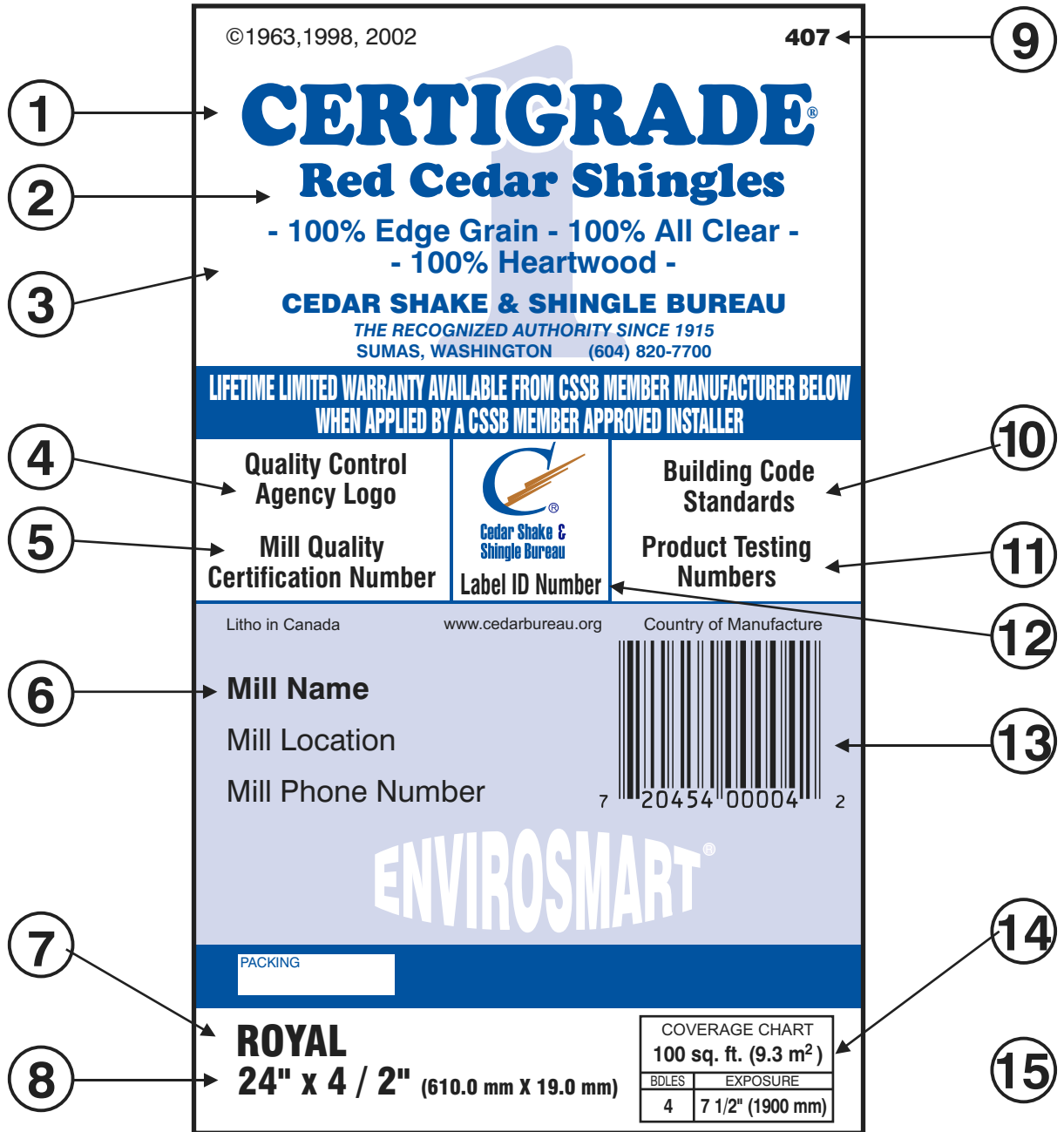

- | | |
|--|---|
| <ol style="list-style-type: none"> 1. The "Certi" Brand Name - Your Quality Assurance 2. Product Grade 3. Product Type 4. Independent, 3rd Party, Quality Control Agency 5. This Number Shows Compliance with Total Quality Manufacturing System 6. Mill Name, Location and Phone Number 7. Industry Product Description | <ol style="list-style-type: none"> 8. Product Dimensions 9. Cedar Bureau Label Number 10. Building Code Compliance Numbers 11. Product Performance Tests Passed 12. Label Identification Number 13. UPC Code 14. Coverage Chart and Recommended Exposure 15. Application Instructions on Reverse Side |
|--|---|



Cedar Shake & Shingle Bureau

Contact us for more information:

TEL: 604-820-7700

FAX: 604-820-0266

www.cedarbureau.org

info@cedarbureau.com

US Address

PO Box 1178
Sumas, WA
98295-1178

Canadian Address

#2 – 7101 Horne St.
Mission, BC
V2V 7A2

This manual shows Cedar Shake & Shingle Bureau recommended procedures as of the manual's print date. It is advisable to contact the Cedar Shake & Shingle Bureau to ensure that you are using the latest available information.

The CSSB logo® ("C" with shingles/shakes), Blue Label®, Certigrade®, Certigroove®, Certi-Cut®, Certi-Guard®, Certi-Last®, Certi-Ridge®, Certi-Sawn®, Certi-Split®, and EnviroSMART® are registered trademarks of the Cedar Shake & Shingle Bureau.

Certi-label™ and other marks appearing in this manual are trademarks of the Cedar Shake & Shingle Bureau.

Please Note:

Length measurements have been rounded to the nearest millimeter.

Area measurements have been rounded to 100th of a square meter.